



Technical Data

13 Amp Socket Outlets

Brief product description:

A range of IP rated accessories designed to protect the potentially dangerous electricity supply in the most arduous of conditions

Features:

- Stylish modern profile
- Colour coded terminals with backed out captive screws for easy installation
- Covers to seal the fixing screws
- 2 Earth terminals in socket except WP23 which has 1
- 1 Earth terminal in mounting box
- All cable entries in the 4 sides have removable blanking caps.
- Housing will accept accessories from the Nexus range
- Cover will stay open to allow for easy access to sockets
- See-through cover allows status of switches to be seen
- Latched type, 30mA trip current, 40mS trip

Product Images



WP21

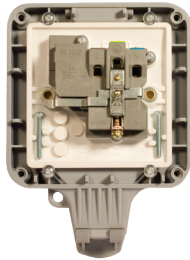

WP21 Rear View



WP23

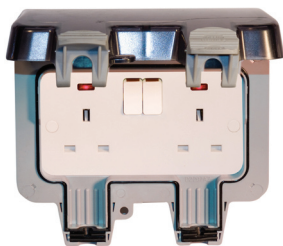

WP22



WP24

13 Amp Socket Outlets

Technical Specifications

Standard(s)	BS 1363 Part 2
Rating	13 Amp 250V~
Switch Type	Double pole (WP21, WP22 products)
Contact Gap	3.0mm minimum (WP21, WP22 products)
Terminal Capacity	3 x 2.5mm ² 3 x 4mm ² 2 x 6.0mm ²
IP Rating	IP66
RoHS Directive	No
WEEE Directive	No
Number of cable entries	5 x 20mm. 1 in each of 3 sides and 2 in the remaining side
	1 drill out entry 20/25mm in rear face (WP21, WP23 products)
	8 x 20mm. 1 in each of the 2 sides and 3 in each of the top and bottom faces
	1 drill out entry 20/25mm in rear face (WP22, WP24 products)
Size	111mm x 154mm x 80mm (WP21, WP23 products)
	171mm x 154mm x 80mm (WP22, WP24 products)

Line Diagrams

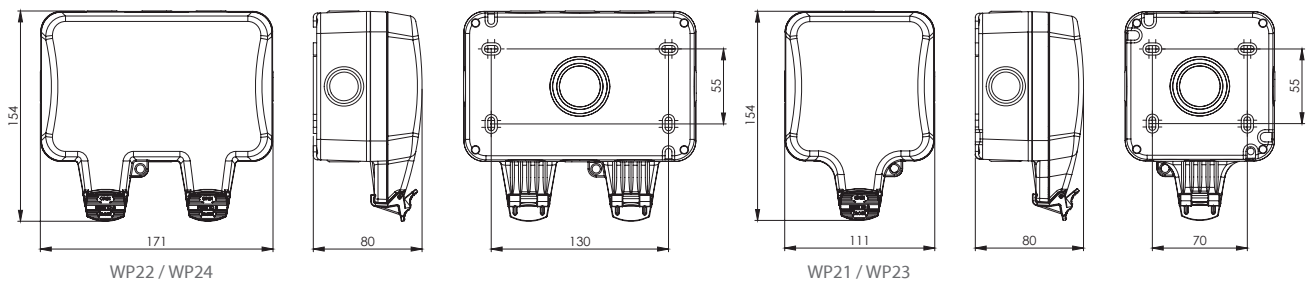

Packaging Information

Cat No.	Description	Packaging Type			Pack Quantity			Barcode		
		Product	Inner Box	Outer Box	Each	Inner Box	Outer Box	Individual	Inner Box	Outer Box
WP21	1G 13A, Sw Skt	Printed Box	/	Printed Outer Box	1	/	10	5050765022170	/	5050765022279
WP22	2G 13A, Sw Skt, DP	Printed Box	/	Printed Outer Box	1	/	10	5050765022200	/	5050765022309
WP23	1G 13A UnSw Skt	Printed Box	/	Printed Outer Box	1	/	10	5050765022187	/	5050765022286
WP24	2G 13A UnSw Skt	Printed Box	/	Printed Outer Box	1	/	10	5050765022194	/	5050765022293

Weights & Dimensions

Cat No.	Description	Dimension (W x L x H) cm			Weight (g)			CMB (m ³)
		Product	Inner Box	Outer Box	Each	Inner Box	Outer Box	Outer Box
WP21	1G 13A, Sw Skt	12 x 9 x 16.5	/	47.5 x 35.5 x 14	330	/	450	0.013
WP22	2G 13A, Sw Skt, DP	18 x 9 x 16.5	/	47.5 x 35.5 x 20	480	/	640	0.033
WP23	1G 13A UnSw Skt	12 x 9 x 16.5	/	47.5 x 35.5 x 14	320	/	450	0.013
WP24	2G 13A UnSw Skt	18 x 9 x 16.5	/	47.5 x 35.5 x 20	470	/	640	0.033

13 Amp Socket Outlets

Installation Information

Safety Warning

Before use please read carefully and use in accordance with these safety wiring instructions.

Before commencing any electrical work ensure the supply is **switched off at the mains**. Either by switching off the consumer unit or by removing the appropriate fuse.

Wiring should be in accordance with the latest edition of the IEE regulations (BS 7671).

Wire Identification – Twin & Earth Cable

EARTH = Green/Yellow Slewing

NEUTRAL = Black (pre Apr 04) / Blue (after Apr 04)

LIVE = Red (pre Apr 04) / Brown (after Apr 04)



Technical Helpline: 0845 194 7584
If in doubt consult a competent electrician.

The ends of the individual conductors should have the insulation removed by approx. 12mm. Any bare earth conductors should be sleeved to within 12mm of the ends. (These details are for general information only and conductor lengths may need to be trimmed in certain installations).

Product Application & Features

The Weatherproof Socket range comprises a robust polycarbonate enclosure with durable integrated 1 or 2 gang Switched or Unswitched Sockets. It provides a convenient & safe wall-mounted power point for outdoor equipment such as DIY & garden tools.

The enclosure is IP rated in use, which means that when the front cover is securely closed, the sealed construction provides a very high level of protection against the ingress of both water & dust.

Access to the socket is by means of the hinged front Cover, which for security reasons can also be locked by padlock (not supplied).

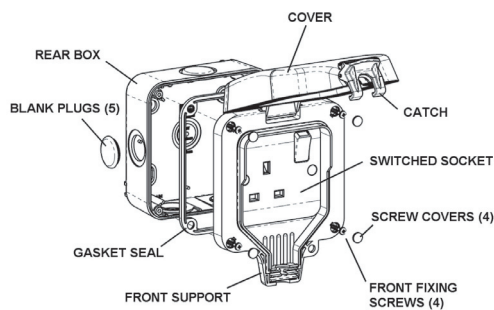

1 GANG SWITCHED SOCKET – EXPLODED VIEW

The Front Assembly comprises Front Support, Switched Socket, Cover & Catch which is mounted to a Rear Box using 4 captive fixing screws. A Gasket Seal is located on the front edge of Rear Box. Re-usable Blank Plugs are pre-fitted & are pushed out from the inside. Screw Covers are provided to hide fixings after installation.

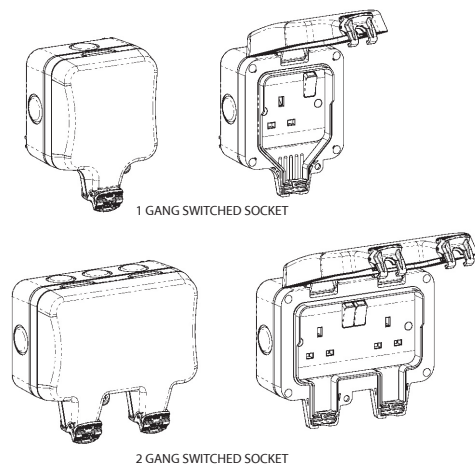

1 GANG SWITCHED SOCKET

2 GANG SWITCHED SOCKET

Safety Instructions – Important

Please Read 'Changes To Building Regulations'

1. An outdoor location should be chosen ensuring adequate access to a mains supply circuit. The circuit **MUST** be protected by an appropriate fuse, circuit breaker or RCD (Residual Current Device) in accordance with current IEE wiring regulations.
2. Where conduit is used for cable runs, water condensation **MUST** be prevented from collecting inside the unit & conduit. Drain holes **MUST** be drilled out (see Installation Instructions)
3. If metal conduit is used, earth continuity across the conduit must be maintained using appropriate connections (not supplied). An earth terminal in the Rear Box is provided as required. An earth connection from supply circuit **MUST** be made to earth terminal of socket.
4. Where outdoor cable runs occur, ensure cable recommended for outdoor installations is used. In general, rubber insulated cable & plastic M20 cable glands can be used. Alternatively standard flat PVC twin & earth mains cable inside 20mm plastic or metal conduit may be used. Where necessary, SWA (Steel Wire Armoured) cable with metal cable glands should be used. The outdoor use of unprotected flat PVC insulated cable is **NOT** recommended.
5. To ensure continued safe & proper weatherproof operation, the unit **MUST** not be left with the Cover raised open or the Catch left unlocked. Unused cable entries **MUST** have Blank Plugs fitted.

Installation Instructions

Ensure Safety Instructions Have Been Read First

Both 1 gang & 2 gang Rear Boxes have multiple cable entries on sides & one rear knockout cable entry. Drain hole positions are provided in relation to conduit positions as shown. Note position of earth terminal.

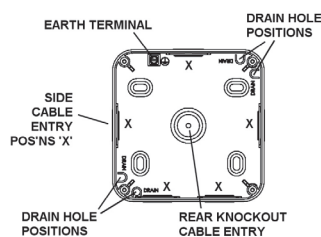

Note

- 1 gang (as shown) has 4 drain hole & 5 cable entry positions.
- 2 gang (not shown) has 2 drain hole & 8 cable entry positions.

1. The unit should be mounted on a clean, rigid vertical surface suitable to accept screw type fixings. Surface should be reasonably flat as unevenness could cause product damage or affect operation.

2. Remove fixing screws & remove Front assembly from Rear Box. (If front assembly is fitted to base)

3. For cable entry, decide if conduit is being used & entry positions.

For side, top or rear entry the lowermost drain hole position **MUST** be drilled out using a 5mm drill. **ONLY ONE** drain hole position must be drilled.

For bottom entry a drain hole **MUST NOT** be drilled in Rear Box, but a drain hole **MUST** be drilled at lowermost point of conduit run.

For rear entry, cut or drill out rear knock-out. For extra sealing protection, a channel around knock-out is provided to accept a bead of sealant (not supplied) when fixing to mounting surface.

Note

The drilling out of a drain hole or removing rear knock-out will reduce the IP rating of the product.

4. Mount the Rear Box using No.8 screws in all four, or at least two diagonal positions on fixing centres shown. The fixing holes are slotted to enable some rotation adjustment if required. Fit supplied Bungs over all used fixing screw positions to seal aperture recesses.

13 Amp Socket Outlets

Installation Information

5. Make cable entry into Rear Box as required. Only remove Blank Plugs for positions used. Ensure adequate excess lengths of cable for connection to socket. Install & seal all cable glands & conduit to manufacturer's instructions. Ensure the Gasket Seal is properly fitted over front edge of Rear Box

6. Offer up Front Assembly to Rear Box to determine final lengths of cables & cut to suit. Strip outer insulation as required & then trim insulation on individual wires 10-12mm to expose conductor ends.

7. Connect the wires to the correct socket rear terminals. The socket terminals are colour coded for easier reference:-

Connect LIVE wire to BROWN LIVE (L) terminal

Connect NEUTRAL wire to BLUE NEUTRAL (N) terminal

Connect EARTH wire to GREEN/YELLOW (E) terminal

Note - the colours of the wires will be dependent on the type of cable used. See Wire Identification section for reference.

8. All earth connections MUST be made & continuity maintained. Note - the Socket has two linked earth terminals but only one needs to be used for this installation.

9. Where any earth conductor is a bare wire, it MUST be sleeved with green/Yellow sleeving.

10. Ensure all terminal screws are tight & all wires are neatly routed & not unduly stretched or pinched.

11. After wiring socket, refit Front Assembly onto Rear Box using fixing screws – DO NOT OVERTIGHTEN. Ensure the Gasket Seal is properly fitted over front edge of Rear Box before tightening screws.

12. Fit Screw Covers to complete installation.

13. Switch power back on, check Socket is working & ensure Cover & Catch operate correctly. The product is now ready to use.

14. For security to prevent unwanted tampering with Socket, a lug feature with a 6mm hole is provided to accept a padlock or similar locking security device (not supplied)

15. During life of product, any cleaning should only be carried out with a damp cloth using a mild solution of detergent & warm water. DO NOT USE solvent based cleaners as these may cause damage. It is recommended to ONLY clean the external surfaces with Cover closed. DO NOT get any water on Socket if Cover is open.

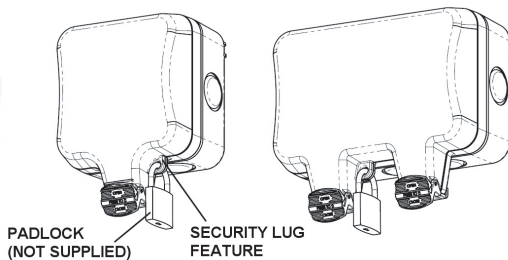
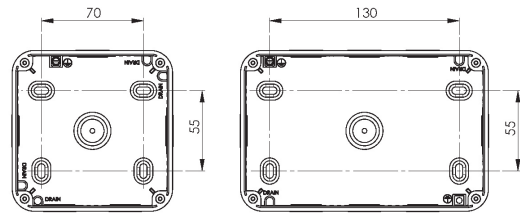

Changes To Building Regulations – Important!

As from 1 January 2005, any electrical work done in domestic, fixed wiring installations in England and Wales, will have to follow new rules & changes to the Building Regulations Part P. These rules have been introduced to help reduce the number of deaths, injuries and fires caused by faulty installations.

The installation work may be carried out by anyone providing it is in accordance with the Regulation standards.

Certain electrical work (non-notifiable or minor work) may be carried out without having to use a registered electrician or notify Local Authority Building Control, such as: -

- replacing any electrical fitting (for example, socket outlets, light fittings, control switches)
- adding fused spurs, sockets or lights to an existing circuit (but not in a kitchen, bathroom or outdoors)
- any repair or maintenance work

For minor work done by a non-qualified electrician, it is highly recommended it is checked by a qualified electrician to ensure it is safe.

For all other work (notifiable or major work) a Building Regulations application is required & it must be checked to make sure it is safe.

This may be done by either an electrician who is part of a competent person self-certification scheme, or by notifying the Local Authority Building Control Department who will make required arrangements.

An application must be made to the Local Authority before commencing work such as: -

- adding a new circuit
- adding/altering any circuit in a room with water (kitchen, bathroom, etc)
- adding/altering any circuit outdoors (outdoor sockets, lights, etc)

Where work is done by a qualified electrician, they will be responsible for checking the work, & Local Authority does not need notification.

Where a qualified electrician or Local Authority is responsible for checking the work, they will provide a certificate or notice to confirm that the installation is tested & safe to use.

IT IS RECOMMENDED TO USE A QUALIFIED ELECTRICIAN

If there is any doubt whether electrical work needs notification of the Local Authority, they should be contacted first for advice.